

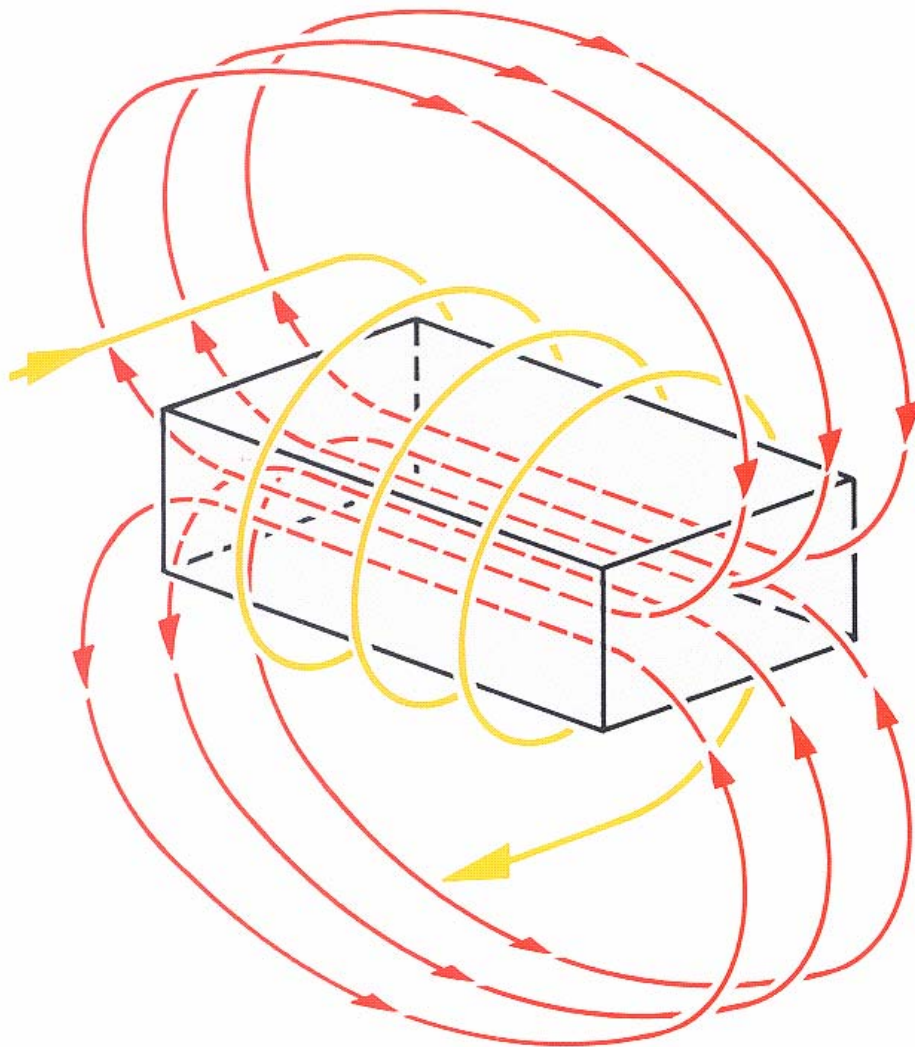

Magnet Guide & Tutorial



For more information please contact:

Alliance LLC
1150 Eastport Center Drive
Valparaiso, IN. 46383
www.Allianceorg.com

Phone: 219-548-3799
Fax: 219-548-7071
e-mail: Engineering@Allianceorg.com

Table of Contents

Introduction	2
History of Magnets	3
Global Trend for Magnets	4
Magnetic Materials Introduction	5
Definitions and Terminology	6
Conversions	10
Hysteresis and Demag Curve	11
Typical Supplier Data Sheets	12
NdFeB at Various Temperatures	15
Attributes of Magnet Materials	16
Highest Properties of Magnets	17
Manufacturing Processes	18
NdFeB and SmCo Manufacturing	19
Alnico Manufacturing	20
Ferrite Manufacturing	21
NdFeB Coatings	22
Adverse Effects on Magnets	23
Magnet Assembly	26
Machining of Magnets	27
Handling of Magnets	28
Magnetization Process	29
Magnetization Types	30
Testing Magnets	31
Initial Design Considerations	34
Selection of Magnet Materials	35
Things to Include on Your Drawing	36
Contact information and References	37



Introduction

This guide has been developed to provide the fundamental basics of magnetic materials, their properties, methods of manufacture, and costing so that the user has adequate knowledge when deciding what type or grade of material should be used in various applications.

Magnets have enormous importance in the modern world. It would be hard to imagine life without their contributions in today's products. Automobiles have several hundred magnets from motor to sensor applications; Consumer electronics utilize them to generate video, sound and record; Computers would not exist; and the medical field would not have the benefit of MRIs and many high RPM instruments used in surgery and dentistry.

The main purpose of magnets is to help in the conversion of energy:

Mechanical to Electrical, such as in generators, sensors and microphones
Electrical to Mechanical, such as in motors, actuators and loudspeakers
Mechanical to Mechanical, such as for couplings, bearing and holding devices

With such importance and the complexities of devices utilizing magnets, they are a relatively easy material to understand. There are only four major types of permanent magnet materials:

NdFeB, Neodymium or Neo Rare Earth
SmCo, Samarium Cobalt
SrFe₂O₃, Hard Ferrites or Ceramics
AlNiCo, Alnico magnets

Then, there are only 4 major magnetic performance properties:

Br, Residual Induction. The magnetic flux that remains permanently in a magnet
Hc and **Hci**, Coercivity. The Susceptibility for demagnetization of the magnet
BH_{max}, Energy Product, The total energy stored in a magnet ($B_r \times H_c$)
T, Temperature Stability. Reversible, irreversible, max working and Curie temps.

In addition to providing a good understanding of the above characteristics, this guide will also provide information related to pricing and availability of all the magnetic materials.

History of Magnetic Materials

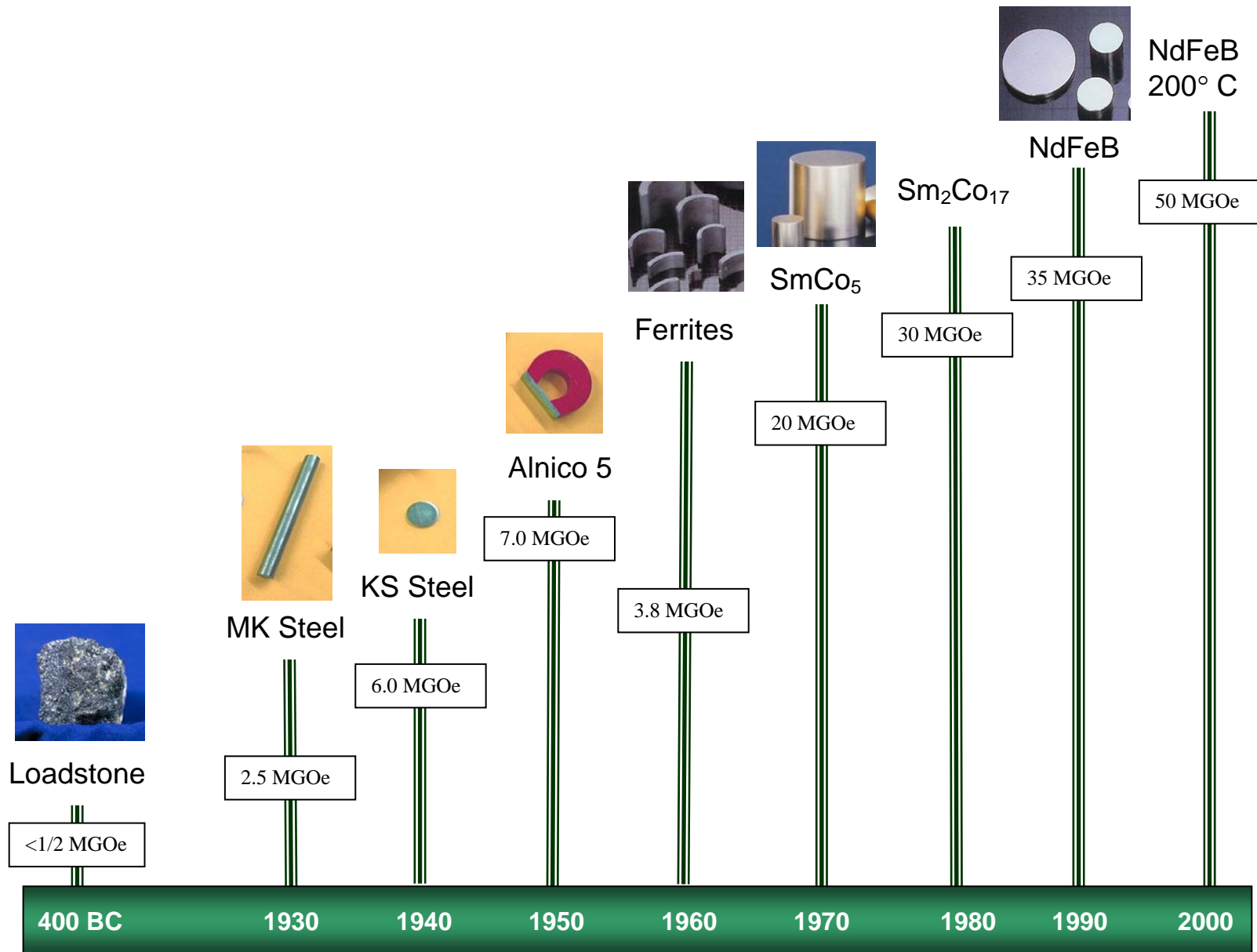

Earliest written reference to magnetism:

"The lodestone makes iron come or it attracts it" from 400BC China

Global Trend for Magnets

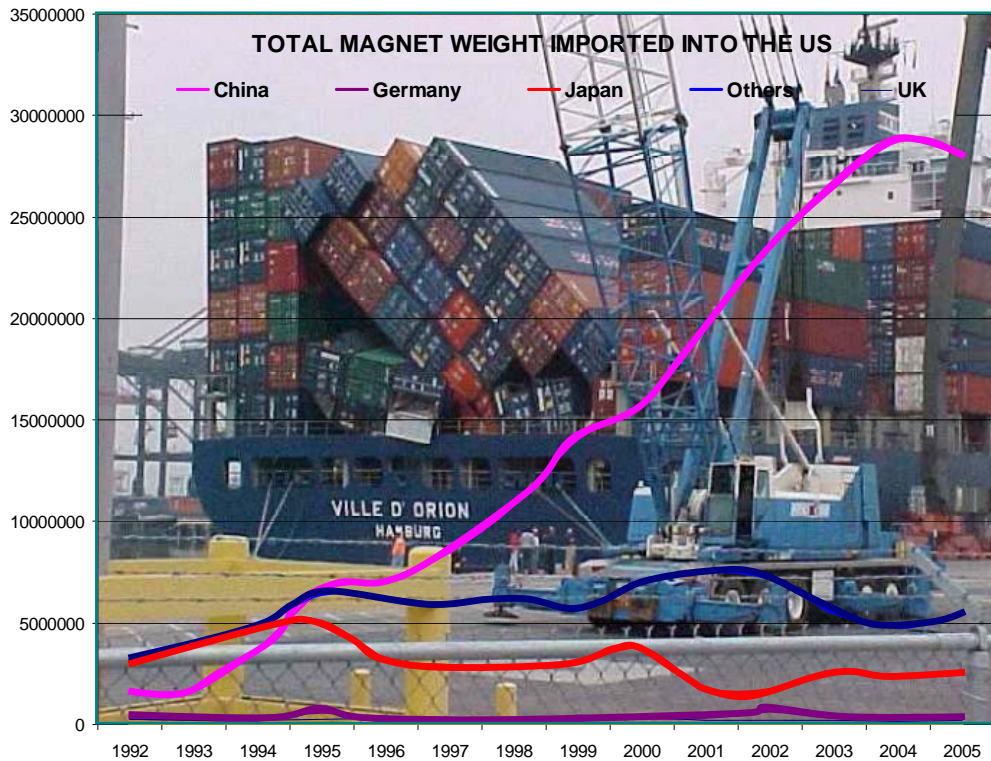
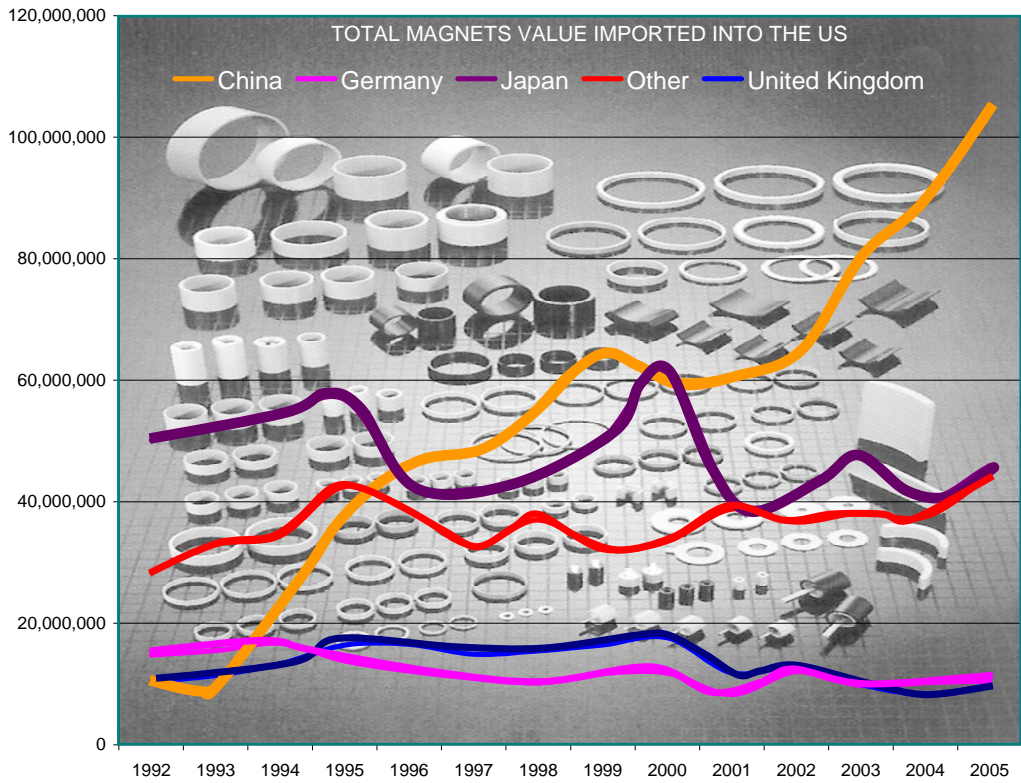

Magnetic Materials Introduction

Ferrites Commonly known as Ceramics, have been in production since the 1950's. They are primarily made from Iron Oxide (FeO) and the addition of Sr and Ba through a calcining process. They are the least expensive and most common of all magnet materials. Primary grades are C1, C5 and C8. They are mostly used in motors and sensors.

Alnico These are one of the oldest commercially available magnets and have been developed from earlier versions of magnetic steels. Primary composition is Al, Ni and Co, hence the name. Although they have a high remanent induction, they have relatively low magnetic values because of their easy of demagnetization. However, they are resistant to heat and have good mechanical features. Common applications are in measuring instruments and high temperature processes such as holding devices in heat treat furnaces.

Samarium Cobalt They belong to the rare earth family because of the Sm and Co elements in their composition. Magnetic properties are high and they have very good temperature characteristics. They are also more expensive than the other magnet materials. They come mostly in two grades: SmCo_5 and $\text{Sm}_2\text{Co}_{17}$, also known as SmCo 1:5 and 2:17. Common uses are in aerospace, military and medical industries.

Neodymium Also known as Neo, these are the strongest and most controversial magnets. They are in the rare earth family because of the Nd, B, Dy, Ga elements in their composition. A relatively new group of commercial magnets, they are controversial because they are the only magnets that have been patented for both composition and processing. The patent and licensing issues are important and will be discussed later in this guide.

Bonded Magnets All of the above materials are available as bonded grades by either extrusion, compression, calendaring or injection molding processes. The magnetic properties are lower because they sometimes lose their anisotropy and they are not fully dense due to the introduction of resins and epoxies. The main advantage to this group is that they can be made in complex shapes and can be insert, over-molded and co-molded with other materials.

Definitions of Terminology in Magnetics

Ag Area of the air gap, or the cross sectional area of the air gap perpendicular to the flux path, is the average cross sectional area of that portion of the air gap within which the application interaction occurs, Area is measured in sq. cm. in a plane normal to the central flux line of the air gap.

Am Area of the magnet, is the cross sectional area of the magnet perpendicular to the central flux line, measured in sq. cm. at any point along its length. In design, Am is usually considered the area at the neutral section of the magnet.

B Magnetic induction, is the magnetic field induced by a field strength, H, at a given point. It is the vector sum, at each point within the substance, of the magnetic field strength and resultant intrinsic induction. Magnetic induction is the flux per unit area normal to the direction of the magnetic path.

Bd Remanent induction, is any magnetic induction that remains in a magnetic material after removal of an applied saturating magnetic field, Hs. (Bd is the magnetic induction at any point on the demagnetization curve; measured in gauss.)

Bd/Hd Slope of the operating line, is the ratio of the remanent induction, Bd, to a demagnetizing force, Hd. It is also referred to as the permeance coefficient, shear line, load line and unit permeance.

BdHd Energy product, indicates the energy that a magnetic material can supply to an external magnetic circuit when operating at any point on its demagnetization curve; measured in megagauss-oersteds.

(BH)max Maximum energy product, is the maximum product of (BdHd) which can be obtained on the demagnetization curve.

Bis (or J) Saturation intrinsic induction, is the maximum intrinsic induction possible in a material.

Bg Magnetic induction in the air gap, is the average value of magnetic induction over the area of the air gap, Ag; or it is the magnetic induction measured at a specific point within the air gap; measured in gauss.

Bi (or J) Intrinsic induction, is the contribution of the magnetic material to the total magnetic induction, B. It is the vector difference between the magnetic induction in the material and the magnetic induction that would exist in a vacuum under the same field strength, H. This relation is expressed by the equation:

$$Bi = B - H$$

Bi = intrinsic induction in gauss

B = magnetic induction in gauss

H = field strength in oersteds.

Bm Recoil induction, is the magnetic induction that remains in a magnetic material after magnetizing and conditioning for final use; measured in gauss.

Bo Magnetic induction, at the point of the maximum energy product (BH)_{max}; measured in gauss.

Br Residual induction (or flux density), is the magnetic induction corresponding to zero magnetizing force in a magnetic material after saturation in a closed circuit; measured in gauss.

f Reluctance factor, accounts for the apparent magnetic circuit reluctance. This factor is required due to the treatment of H_m and H_g as constants.

F Leakage factor, accounts for flux leakage from the magnetic circuit. It is the ratio between the magnetic flux at the magnet neutral section and the average flux present in the air gap.

$$F = (B_m A_m) / (B_g A_g)$$

F Magnetomotive force, (magnetic potential difference), is the line integral of the field strength, H, between any two points, p₁ and p₂.

$$F = \int_{p_2}^{p_1} H \, dl$$

F = magnetomotive force in gilberts

H = field strength in oersteds

dl = an element of length between the two points, in centimeters.

H Magnetic field strength, (magnetizing or demagnetizing force), is the measure of the vector magnetic quantity that determines the ability of an electric current, or a magnetic body, to induce a magnetic field at a given point; measured in oersteds.

Hc Coercive force of a material, is equal to the demagnetizing force required to reduce residual induction, B, to zero in a magnetic field after magnetizing to saturation; measured in oersteds.

Hci Intrinsic coercive force of a material, indicates its resistance to demagnetization. It is equal to the demagnetizing force which reduces the intrinsic induction, B_i, in the material to zero after magnetizing to saturation; measured in oersteds.

Hd is that value of H corresponding to the remanent induction, B_d; measured in oersteds.

Hm is that value of H corresponding to the recoil induction, B_m; measured in oersteds.

Ho is the magnetic field strength at the point of the maximum energy product (BH)_{max}; measured in oersteds.

Hs Net effective magnetizing force, is the magnetizing force required in the material, to magnetize to saturation measured in oersteds.

J, see B_i, Intrinsic induction.

Js, see Bis Saturation intrinsic induction.

lg Length of the air gap, is the length of the path of the central flux line of the air gap; measured in centimeters.

lm Length of the magnet, is the total length of magnet material traversed in one complete revolution of the center line of the magnetic circuit; measured in centimeters.

lm/D Dimension ratio, is the ratio of the length of a magnet to its diameter, or the diameter of a circle of equivalent cross-sectional area. For simple geometries, such as bars and rods, the dimension ratio is related to the slope of the operating line of the magnet, Bd/Hd.

P Permeance, is the reciprocal of the reluctance, R, measured in maxwells per gilbert.

R Reluctance, is somewhat analogous to electrical resistance. It is the quantity that determines the magnetic flux, ϕ , resulting from a given magnetomotive force, F.

$$R = F/\phi$$

R = reluctance, in gilberts per Maxwell

F = magnetomotive force, in gilberts

ϕ = flux, in Maxwells

Tc, Curie temperature, is the transition temperature above which a material loses its magnet properties.

Tmax Maximum service temperature, is the maximum temperature to which the magnet may be exposed with no significant long range instability or structural changes.

Vg Air gap volume, is the useful volume of air or non-magnetic material between magnetic poles; measured in cubic centimeters.

μ permeability, is the general term used to express various relationships between magnetic induction, B, and the field strength, H.

μ re recoil permeability, is the average slope of the recoil hysteresis loop. Also known as a minor loop.

ϕ magnetic flux, is a contrived but measurable concept that has evolved in an attempt to describe the "flow" of a magnetic field. Mathematically, it is the surface integral of the normal component of the magnetic induction, B, over an area, A.

A closed circuit condition exists when the external flux path of a permanent magnet is confined with high permeability material.

The demagnetization curve is the second (or fourth) quadrant of a major hysteresis loop. Points on this curve are designated by the coordinates Bd and Hd

A Fluxmeter is an instrument that measures the change of flux linkage with a search coil.

The Gauss is the unit of magnetic induction, B , in the cgs electromagnetic system. One gauss is equal to one maxwell per square centimeter.

A Gaussmeter is an instrument that measures the instantaneous value of magnetic induction, B . Its principle of operation is usually based on one of the following: the Hall-effect, nuclear magnetic resonance (NMR), or the rotating coil principle.

The Gilbert is the unit of magnetomotive force, F , in the cgs electromagnetic system.

A Hysteresis loop is a closed curve obtained for a material by plotting (usually to rectangular coordinates) corresponding values of magnetic induction, B , for ordinates and magnetizing force, H , for abscissa when the material is passing through a complete cycle between definite limits of either magnetizing force, H , or magnetic induction, B .

Irreversible losses are defined as partial demagnetization of the magnet, caused by exposure to high or low temperatures external fields or other factors. These losses are recoverable by remagnetization. Magnets can be stabilized against irreversible losses by partial demagnetization induced by temperature cycles or by external magnetic fields

A keeper is a piece (or pieces) of soft iron that is placed on or between the pole faces of a permanent magnet to decrease the reluctance of the air gap and thereby reduce the flux leakage from the magnet. It also makes the magnet less susceptible to demagnetizing influences.

Leakage flux is flux, ϕ , whose path is outside the useful or intended magnetic circuit; measured in maxwells.

The major hysteresis loop of a material is the closed loop obtained when the material is cycled between positive and negative saturation.

The Maxwell is the unit of magnetic flux in the cgs electromagnetic system. One maxwell is one line of magnetic flux.

The neutral section of a permanent magnet is defined by a plane passing through the magnet perpendicular to its central flux line at the point of maximum flux.

The Oersted is the unit of magnetic field strength, H , in the cgs electromagnetic system. One oersted equals a magnetomotive force of one gilbert per centimeter of flux path.

An open circuit condition exists when a magnetized magnet is by itself with no external flux path of high permeability material.

The operating line for a given permanent magnet circuit is a straight line passing through the origin of the demagnetization curve with a slope of negative B_d/H_d . (Also known as permeance coefficient line.)

The operating point of a permanent magnet is that point on a demagnetization curve defined by the coordinates (B_d/H_d) or that point within the demagnetization curve defined by the coordinates (B_m/H_m) .

An oriented (anisotropic) material is one that has better magnetic properties in a given direction.

A permeameter is an instrument that can measure, and often record, the magnetic characteristics of a specimen.

Reversible temperature coefficients are changes in flux which occur with temperature change. These are spontaneously regained when the temperature is returned to its original point.

Magnetic saturation of a material exists when an increase in magnetizing force, H, does not cause an increase in the intrinsic magnetic induction, B, of the material.

A search coil is a coiled conductor, usually of known area and number of turns, that is used with a fluxmeter to measure the change of flux linkage with the coil.

The temperature coefficient is a factor which describes the reversible change in a magnetic property with a change in temperature. The magnetic property spontaneously returns when the temperature is cycled to its original point. It usually is expressed as the percentage change per unit of temperature.

An unoriented (isotropic) material has equal magnetic properties in all directions.

Conversions

Designation	CGS	SI	Conversion
H	Oersted (Oe)	A/m	$1\text{A/m} = 12.57 \times 10^3 \text{ Oe}$
B	Gauss (G)	Tesla (T)	$1 \text{ T} = 10,000 \text{ G}$
ϕ	Maxwell (M)	Weber (Wb)	$1 \text{ Wb} = 10^8 \text{ M}$
F	Gilbert	Amp-turn	$1 \text{ A-t} = 1.256 \text{ Gilbert}$
BH	MGOe	Joule/m ³	$1 \text{ J/m}^3 = .1257 \times 10^6 \text{ GOe}$

Hysteresis and Demagnetization Curves

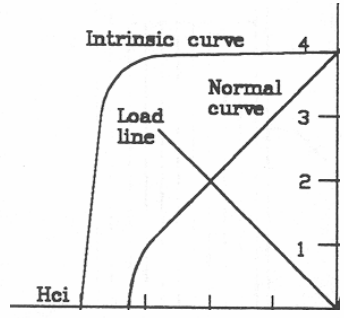
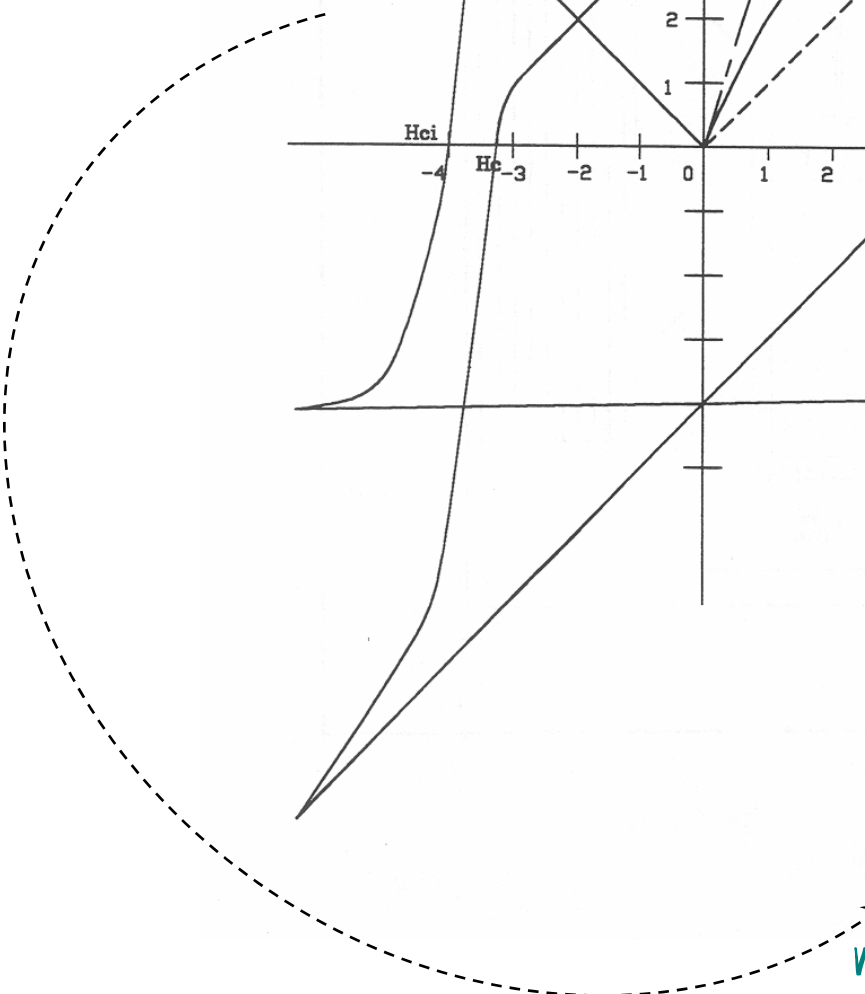
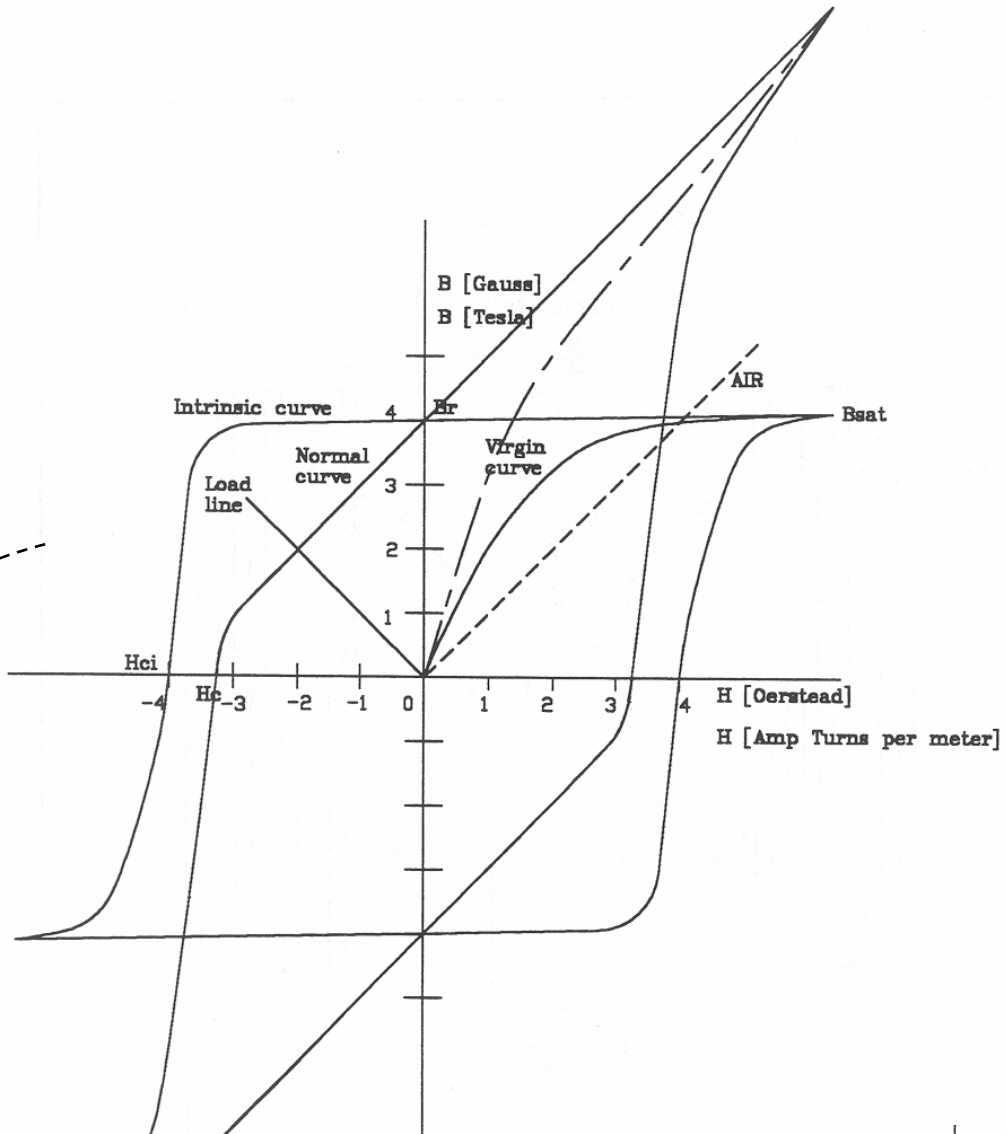

What is commonly seen in supplier catalogs

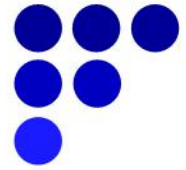

www.Allianceorg.com

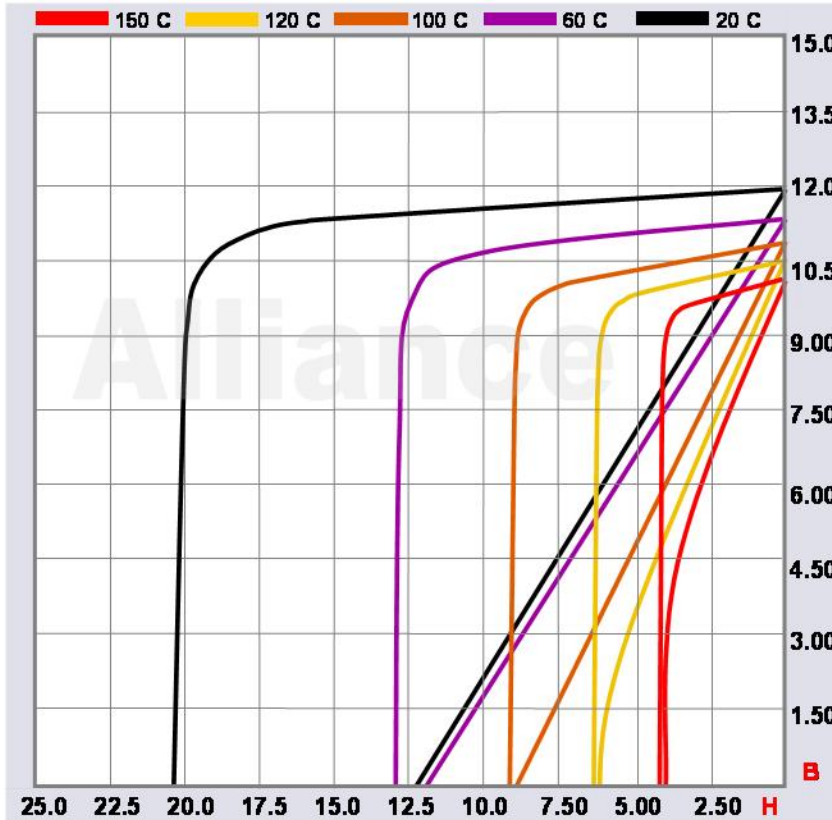

NdFeB N-45M

		Typical	Minimum
Residual Induction Br	G	13,300	13,700
Coercive Force Hc	Oe	10,800	11,200
Intrinsic Coercive Force Hci	Oe		14,000
Max. Energy Product (BH)max	MGOe	43	46
Material Density	Lb/in3	.2673	
Max. Operating Temperature	C	100	
Temperature Coefficient for B	-%/C	0.11	
Temperature Coefficient for H	-%/C	0.60	
Required Magnetizing Force	Oe	60,000	
Material Composition	Nd, B, Fe, Dy, Co		

Neodymium Iron Boron magnets, also known as Rare Earths or Neo, have the highest energy product of all permanent magnet materials today. In most cases, no tooling charges exist. Various grades are available, depending on maximum operating temps.

For more information please call or email Alliance technical support at:

Phone: 219-548-3799 Fax: 219-548-7071 email: engineering@allianceorg.com

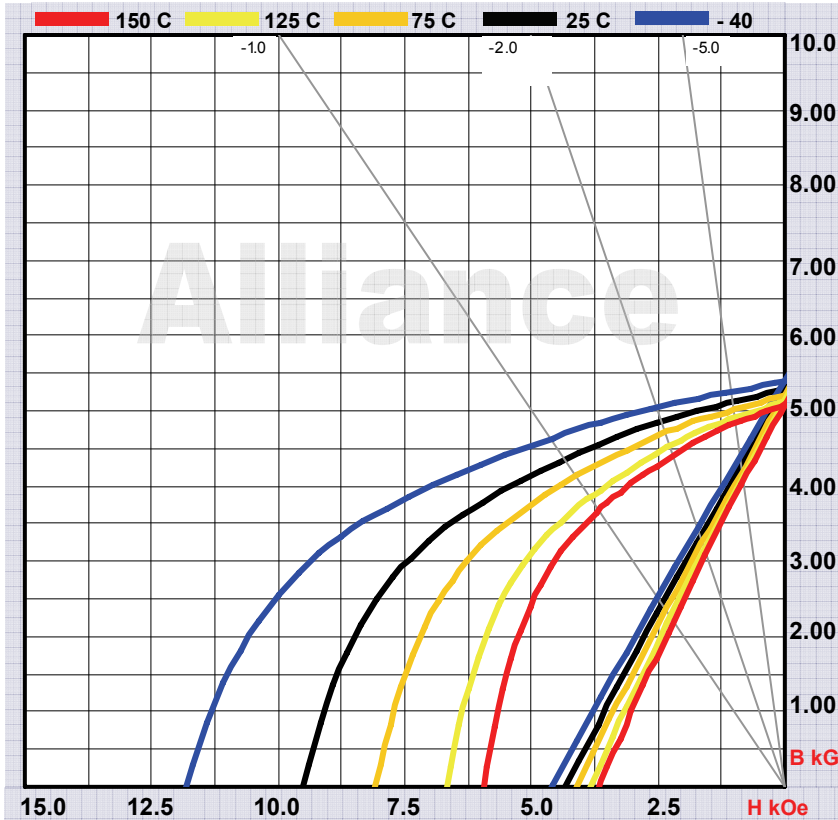

		Typical	Minimum
Residual Induction Br	G	6,400	6,800
Coercive Force Hc	Oe	5,320	5,720
Intrinsic Coercive Force Hci	Oe		9,420
Max. Energy Product (BH)max	MGOe	10.3	?
Material Density	g/cm ³	4.5	
Max. Operating Temperature	C	150	
Temperature Coefficient for B	-%/C	0.03	
Temperature Coefficient for H	-%/C	0.30	
Required Magnetizing Force	Oe	25,000	
Material Composition	SmCo powder w/ various resins		

Injection Molded Samarium Cobalt magnets are made with SmCo powder compounded with a binder material which is then molded into highly complex shapes or co-injected with other materials to form complete assemblies. Very low magnetic degradation at elevated temperatures.

For more information please call or email Alliance technical support at:

NdFeB Magnet Grade at Various Temperatures

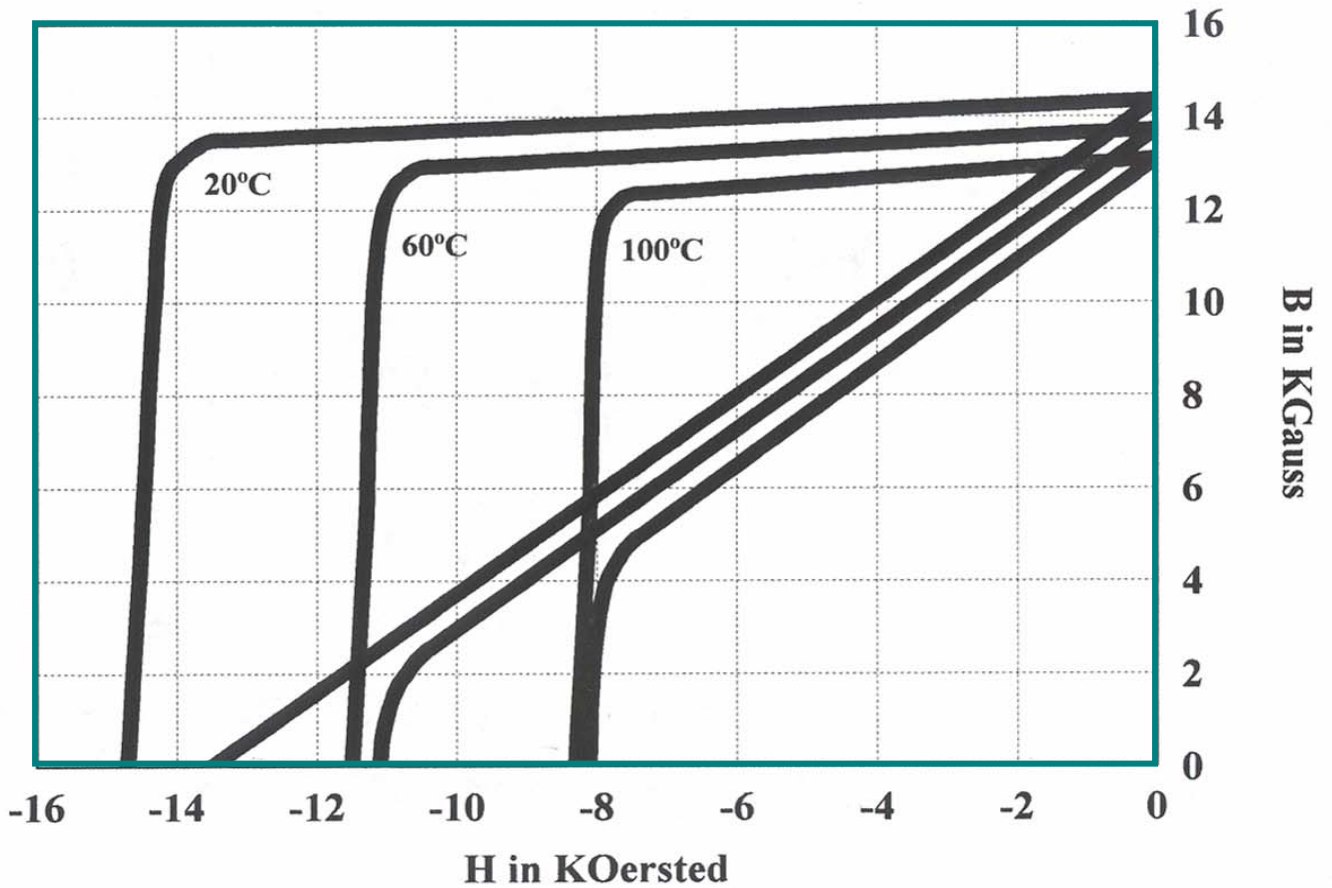

NdFeB loses approximately 0.11 % Br for every degree C above 20°C. This is called the Reversible Temperature Coefficient.

Magnet Materials

Materials	Typical Shapes	Pro	Con
Cast Alnico AlNiCo	Rods, Bars, U shape and other cast type	High Br High working T Good T coef.	Very Low Hc High cost High L/D Requires Cast
Sintered Alnico AlNiCo	Powder pressed to shape	Complex shapes High Br, T	Requires Tool High cost Low market
Ceramic/Ferrite SrFe₂O₃	Blocks, Rings, Arcs, Discs	Most flux for \$ High usage Low corrosion	Low Br Requires tool Simple shapes
Samarium Cobalt SmCo	Blocks, Rings, Discs Arcs, Segments	No corrosion Very low T coef Stable, No tool	Very expensive Simple shapes High Co content
Neodymium NdFeB	Blocks, Rings, Discs Arcs, Segments	Highest magnetic properties No tooling	Corrodes Low working T Difficult to Mag
Bonded Grades All materials	Difficult geometries Can be insert molded or overmolded	Complex shapes Various resins	High toolings Low magnetics High volumes

There are other magnet materials which are used much less frequently:

- Manganese Aluminum Carbon
- Iron Chrome Cobalt
- Cunife
- Wire drawn Alnico
- HDDR type Neo
- Extruded Neo
- Platinum Iron Neo

Highest Properties of Each Magnetic Material

Material	Br	Hc	Hci	(BH)max	$\Delta Br/\Delta T$
SrFe₂O₃	4000	3600	4100	4.0	-.18
Alnico 5	12700	640	650	5.5	-.02
Alnico 9	10500	1500	1520	10.5	-.02
SmCo₅	10000	9500	12500	24.0	-.03
Sm₂Co₁₇	11300	8000	>9000	28.0	-.03
NdFeB	14250	11500	>12000	50.0	-.11
NdFeB (UH)	11900	10300	>25000	42.0	-.11
MnAlC	5500	2500	>2500	5.5	-.11

- These materials do not include bonded types
- The greatest advances in magnetics are being done in the area of Neo
- Neo is becoming stronger and with a higher working temperature
- New methods of manufacturing are being developed

Manufacturing Processes

Depending on the type of material, the following processes are used to manufacture permanent magnets:

Sintering The sintering process involves compacting fine powders at high pressures in an aligning magnetic field, then sintering it into a solid shape. After sintering, the “ingot” is rough and must be machined to achieve close tolerances. The complexity of shapes that can be pressed using this process is limited.

Neodymium and Samarium cobalt powders are compressed to form magnets by:

- **Isostatic pressing** The powder is compacted with the same force from all directions. These magnets have the highest possible magnetic values because of the higher density achieved using this technique.
- **Compressing in tools:**
 1. *Transverse Field Pressing.* The powder is compacted at right angles to the magnetic flux. These magnets have a weaker field compared to the isostatic pressed ones, but stronger compared to the parallel pressed magnets.
 2. *Parallel Compressing.* The powder is compacted parallel to the magnetic field.

Compression Molding This method is commonly used to make NdFeB magnets using melt spun Nd powders that are epoxy coated. The powders are compacted and then heat cured for the epoxy to perform the binding function. These magnets are typically isotropic.

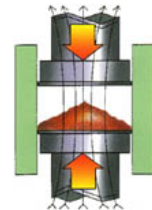

Injection Molding Neodymium, Samarium Cobalt, and Ferrite Materials can be manufactured by injection molding. Common binders for injection molding are polyamides. The advantage of using this method is the possibility to get a better tolerance directly from the tool with no required heat treatment, and the magnets can be produced in complex shapes. They can be combined with other materials for over-molding or insert molding.

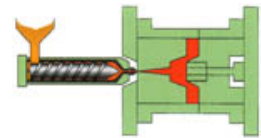

Casting This process is used for manufacturing Alnico. Process is similar to the casting of other metals. Parts are formed in sand casts which can be complex.

Calendering and Extruding Flexible NdFeB and Ferrite magnets with Nitrile rubber binders are made using this method. The process is similar to that for vinyl sheets. Parts are later die cut or stamped from sheets of various thicknesses.

Manufacturing of Neo and SmCo Magnets

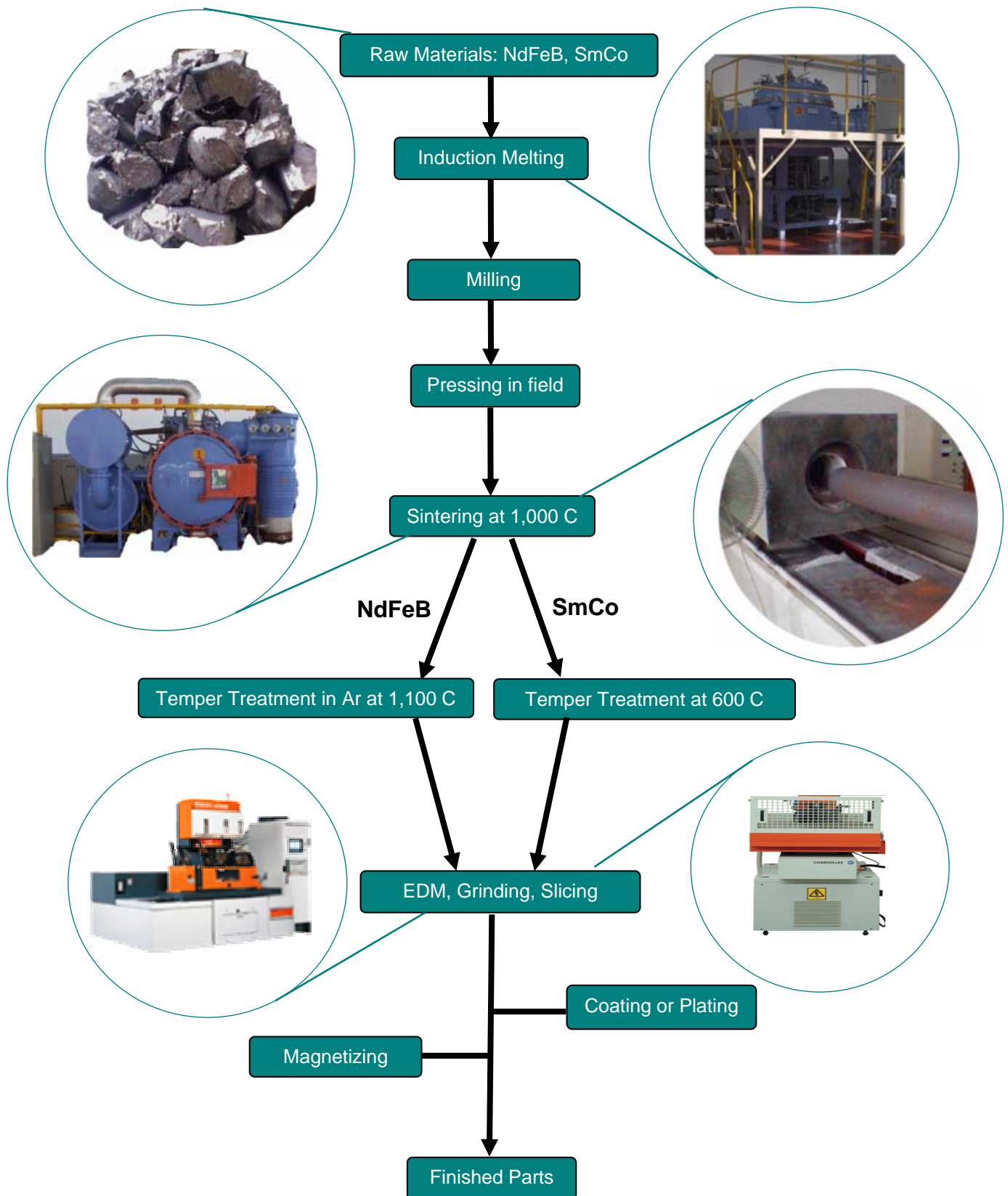

Manufacturing of AlNiCo Magnets

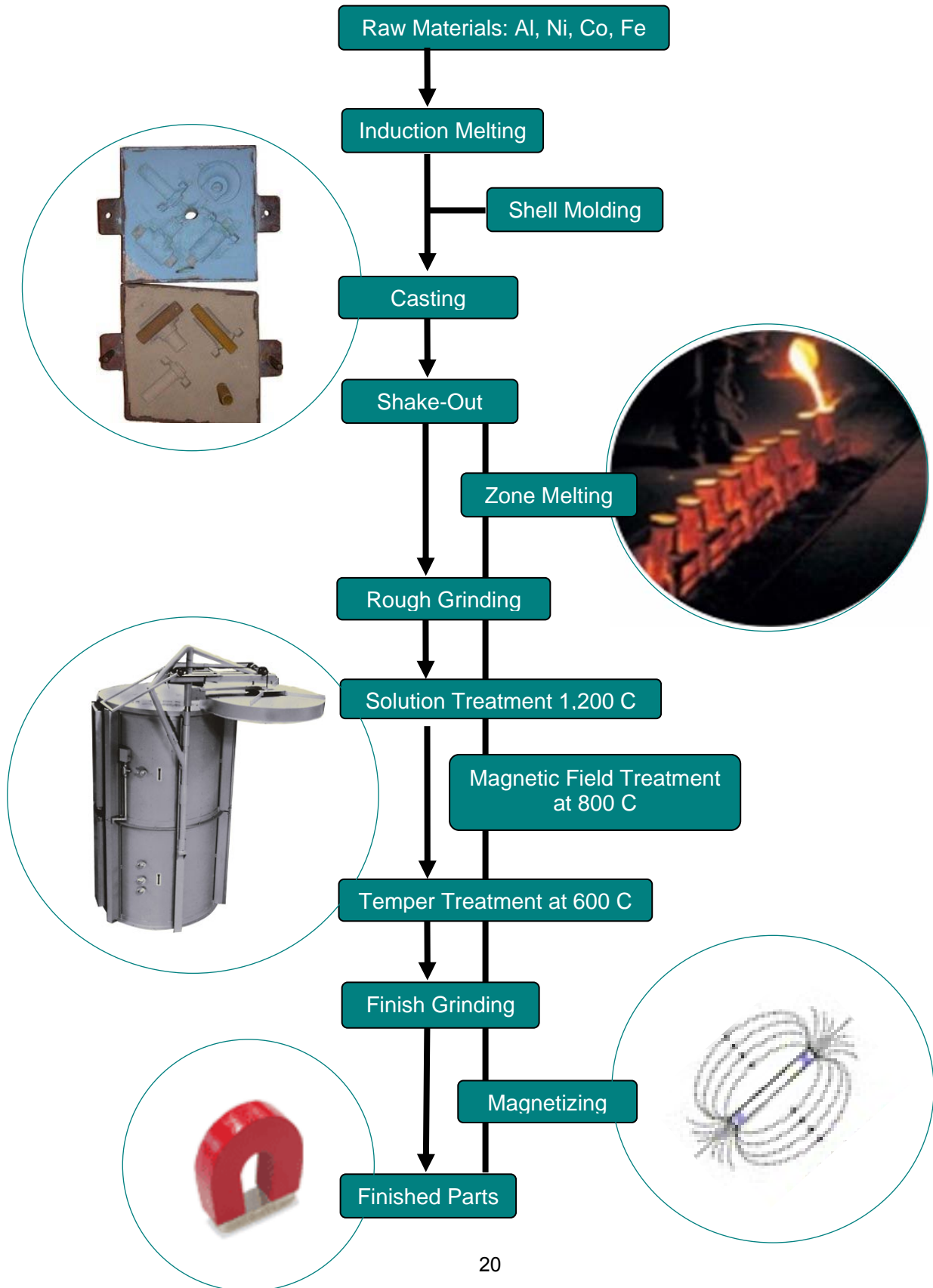

Manufacturing of Ferrites (Ceramic) Anisotropic Wet Pressed

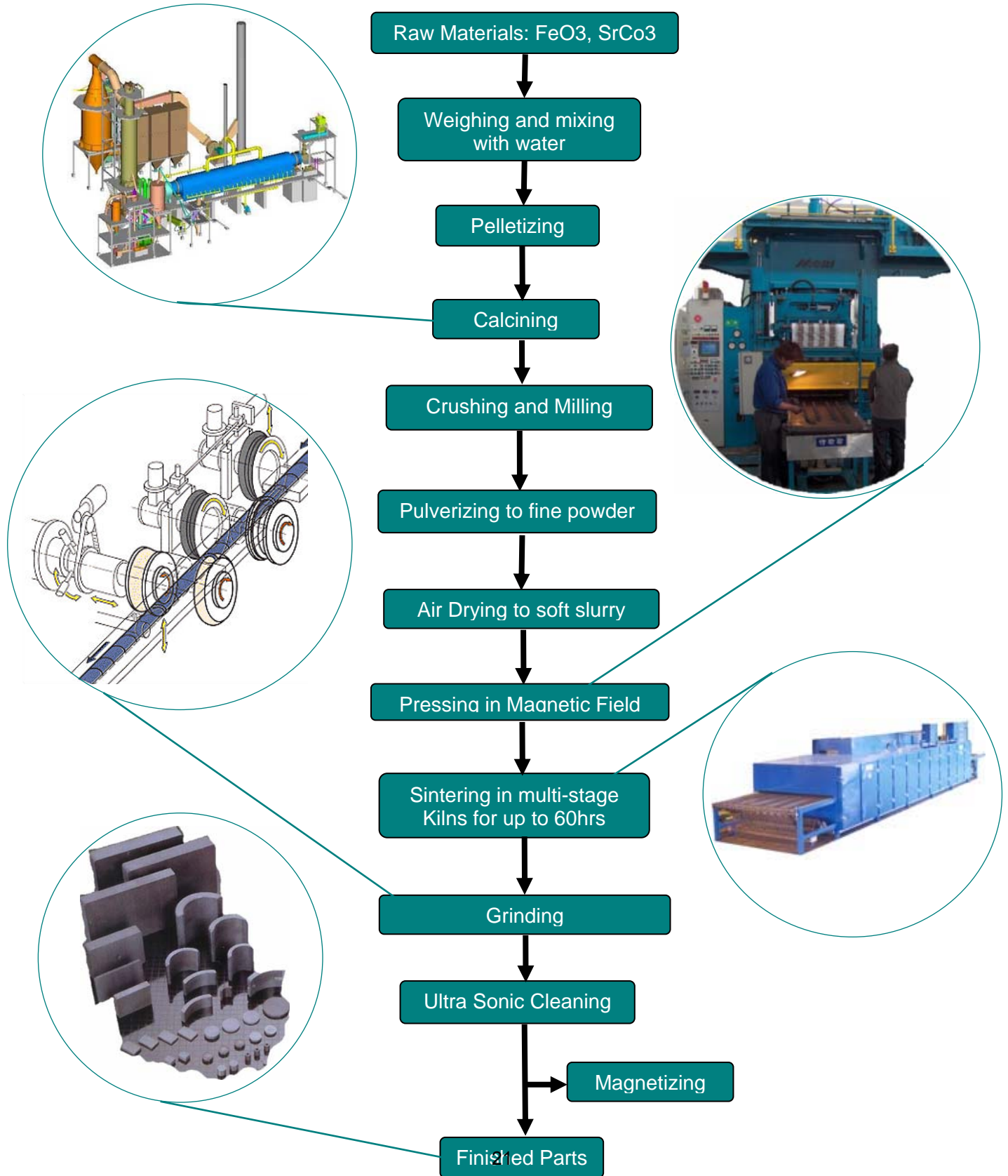

NdFeB Coatings

Properties	Organic: E-Coat	Metallic: Nickel Plating
Application Type	Immersion Electrodeposition Epoxy/Urethane Water Based	Immersion Barrel Electroplate Electroless
Pretreat Process	Alkaline Clean Acid Etch/Passivate	Alkaline Clean Electroclean Acid Etch/Activate
Thickness	15-25 μ (0.6-1.0 mil)	10-50 μ (0.4-2.0 mil)
Uniformity (Flatness/Edges)	Excellent 20% Edge Loss	Good 50% Edge Gain
Durability	Good Pencil 2H-4H	Excellent 300-1000 V₁₀₀
Temp and Humidity at 85°C and 85% RH	250 Hours	Over 1200 Hours

Things to consider when specifying coatings:

- Platings can be electroless Zn, Ni, Ni-Cu-Ni, Cu-Ni
- Must have 100% corrosion protection
- Protect against oxidation at high temperatures
- Encapsulate all magnetic particles
- Chip and crack resistance
- Determine functional properties: bonding of magnet, dielectric, oils
- Coatings will have different appearance. Epoxy coat can be many colors

Adverse Effects on Magnetic Performance

Permanent magnets in external magnetic fields work because of the small magnetic domains which are in "locked" positions and direction. When this formation is formed by the initial magnetization, the positions are held until the magnet is exposed to external forces of larger magnitude than the forces which locked the domain positions and direction. The force needed to affect these domains within the magnetic material vary depending on the material. Permanent magnets can be produced with extremely strong inner forces (H_{ci}), which hold the domains in place within the magnet even after exposure of strong external magnetic fields. Magnetic Stability can be explained as the magnet's ability to preserve its magnetic characteristics after repeated exposure of external magnetic fields. Factors that affect a magnet's stability are time, temperature, change in reluctance, external magnetic fields, radiation, and vibration.

Time

The effect of time on modern permanent magnets is minimal. Magnets will see changes immediately after magnetization. These changes, known as "magnetic creep", occur as less stable domains are affected by fluctuations in thermal or magnetic energy, even in a thermally stable environment. This variation is reduced as the number of unstable domains decreases. Rare Earth magnets are less likely to experience this effect because of their high coercivity. Studies have shown that a newly magnetized magnet will lose only a minor percent of its flux as a function of age.

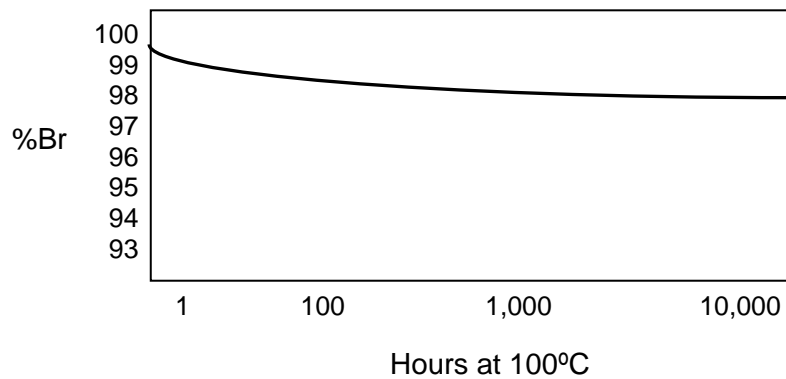

Temperature

Temperature effects fall into three categories:

- **Reversible losses**
- **Irreversible losses**
- **Metallurgical changes**

Reversible Losses

These are losses that are recovered when the magnet returns to its original temperature. Reversible losses cannot be eliminated by magnet stabilization. Reversible losses are described by the Reversible Temperature Coefficient, $-\%Br/^{\circ}C$, shown in the table below. These losses vary for different magnet materials and are not always linear as the temperature increases. For example, a NdFeB magnet with a -0.11 reversible loss will have 11% less magnetic flux at $120^{\circ}C$ than at $20^{\circ}C$.

Material	Tc of Br	Tc of Hc
Neodymium	-0.11	-0.60
Samarium cobalt	-0.03	-0.30
Alnico	-0.02	+0.01
Ferrite	-0.18	+0.30

Reversible temperature coefficients of Br and Hc

Irreversible Losses

These losses are defined as a partial demagnetization of the magnet from exposure to high or low temperatures or other demagnetizing influences. These losses are only recoverable by remagnetization and are not recovered when the temperature returns to its original value. This occurs when the magnets are used at temperatures higher than the specified "maximum operating temperature" or when the operating point of the magnet falls below the "knee" of the demagnetization curve.

Metallurgic changes

Metallurgic changes occur when magnets are exposed to extremely high temperatures that are usually as high as the initial heat treatment when they were manufactured. This is called the magnet's Curie temperature. When a metallurgic change occurs, the magnetic properties are not recoverable to the previous state even after remagnetization. At the Curie temperature, magnetic domains lose their "locked" positions and regain a random orientation in the material. The table below shows Curie temperatures for various materials.

Material	Tc	Tmax
Neodymium	310	150
Samarium cobalt	750	300
Alnico	860	540
Ferrite	460	300

Curie (Tc) and max working temperatures for different materials in $^{\circ}C$

Reluctance

These changes occur when a magnet is subjected to permeance changes such as changes in the air gap dimensions during operation. These changes will change the reluctance of the circuit and may cause the magnet's operating point to fall below the knee of the curve, causing partial and/or irreversible losses. The extent of these losses depend on the material properties and the extent of the permeance change. Stabilization may be achieved by pre-exposure of the magnet to the expected reluctance changes.

Adverse and Stray Fields

External magnetic fields in repulsion modes will produce a demagnetizing effect on permanent magnets. Alnico, with a coercive force of only 650 Oe, will encounter magnetic losses in the presence of any magnetic repelling force, including similar magnets. Applications involving Ferrite magnets with a coercive force of about 4 kOe should be carefully evaluated in order to assess the effect of external magnetic fields. NdFeB magnets will partially or completely demagnetize Ferrite magnets when they are placed too close or are touching each other. NdFeB and Samarium Cobalt magnets with coercive forces exceeding 15 kOe are rarely affected by repelling forces.

Radiation

It is usually recommended that magnets with high Hci values in objects which are exposed for radiation be operated at high permeance coefficients, and that they be shielded from direct heavy particle irradiation. Stabilization can be achieved by pre-exposure to expected radiation levels.

Shock, Stress and Vibration

Below destructive limits, these effects are very minor on modern magnet materials. However, rigid magnet materials are brittle in nature and can be easily damaged or chipped by improper handling. Samarium Cobalt in particular is a fragile material and special handling precautions must be taken to avoid damage. Thermal shock when Ferrite and Samarium Cobalt magnets are exposed to high temperature gradients can cause fractures within the material and should be avoided. Even though Samarium Cobalt magnets do not corrode, and thus do not require plating, they are sometimes plated to provide them better resistance to forces that would cause structural damage.

Magnet Assembly

Because all magnetic materials are brittle and, in many cases, magnetized prior to assembly, care must be taken when using magnets in assemblies that require further processing. For example, when molding sensor components which use magnets that have already been magnetized, many types of magnets will demagnetize and/or crack during the molding operation. Here are some common magnet assembly processes:

Gluing Magnets

Magnets can be glued to metal rotors, housings, or onto shafts using structural acrylic, cyanoacrylate, and single or two part adhesives which are rated at temperatures up to 250°C. Many adhesives available today have fast cure times to avoid the need for fixturing the magnets in place while the bond cures. Adhesives with higher temperature ratings normally require oven curing, and fixturing of the magnets to hold them in place. If magnet assemblies are to be used in a vacuum, potential outgassing of the adhesives should be considered. The most common adhesives used when gluing magnets to other materials are Loctite Henkel (Hysol brand), Eccobond and Bondmaster by National Starch, 3M Scotchweld, and several other epoxy brands.

Mechanical Fastening

When a number of magnets must be assembled, especially when the magnets must be placed in repelling positions, it is very important to consider safety issues. Modern magnetic materials such as Samarium Cobalt and Neodymium are extremely powerful, and when in repulsion they can behave as projectiles if adhesives were to break down. It is recommended that when magnets are used in fast rotating applications, or under other high stresses, mechanical fastening and/or encapsulating with non magnetic metals should be considered as part of the assembly design.

Potting

Assemblies containing multiple magnets, such as in rotors, should be potted to fill gaps or to cover entire arrays of magnets. Potting compounds cure to hard and durable finishes, and are available to resist a variety of environments, such as elevated temperatures, water flow turbulence, etc. When cured, the potting compounds are sometimes machined to provide accurate finished parts. Recently, many companies have been using glass fiber tape instead of stainless steel shells for encapsulating magnets on high speed rotors. The advantage is an easier application that can be done in-house and they are somewhat less expensive than stainless steel shells that must be ground to very tight tolerances. The disadvantage to the tape is that larger air gaps, for example between the rotor and stator, are required.

Welding

Assemblies which are required to be hermetically sealed can be welded using either laser welding (which is not affected by the presence of magnetic fields) or TIG welding (using appropriate shunting elements to reduce the effect of magnetic fields on the weld arc). Special care should be taken when welding magnetic assemblies so that heat dissipation of the weld does not cause irreversible magnetic losses.

Machining of Magnets

Sintered Samarium Cobalt and Ferrite magnets exhibit small cracks within the material that occur during the sintering process. Provided that the cracks do not extend more than halfway through a section, they do not normally affect the operation of the magnet. This is also true for small chips that may occur during machining and handling of these magnets, especially on sharp edges. Magnets may be tumbled to break edges. This is done to avoid "feathering" of sharp edges due to the brittle nature of magnets and is also done for better adhesion of plating or coatings. Because of these inherent material characteristics, it is not advisable to use any permanent magnet material as a structural component of an assembly.

Neodymium magnets are more durable compared to Samarium Cobalt and Ferrite magnets, however they are still brittle and they should be handled with care. Since permanent magnets are produced of brittle material, they should not be used as bearing components of an assembly.

Sintered Neodymium, Samarium Cobalt and Ferrite magnets are machined by grinding, which may affect the magnet cost. Maintaining simple geometries and wide tolerances is therefore desirable from an economic point of view. Generally, tolerances less than ± 0.005 " will result in higher costs, regardless of the size of the part. Rectangular or round sections are preferable to complex shapes. Square holes and very small holes (less than .250") are difficult to machine and should be avoided.

Cast Alnico magnets exhibit porosity as a natural consequence of the casting process. This may become a problem with small shapes which are machined out of larger castings. The voids occupy a small portion of the larger casting, but can account for a large portion of the smaller fabricated magnets. This may cause a problem where uniformity or low variation is critical, and it may be advisable either to use a sintered Alnico, or another material.

Handling Of Magnets

- Personnel wearing pacemakers must not handle magnets.
- Magnets should be kept away from sensitive electronic equipment, computer disks, and credit cards with magnet stripes.
- Modern magnet materials are extremely strong magnetically and somewhat weak mechanically. Therefore, packaging is an important issue.
- Any person required to handle magnets should be appropriately trained about the potential dangers of handling magnets.
- Injury is possible to personnel, and magnets themselves can easily get damaged if allowed to snap towards each other, or if nearby metal objects are allowed to be attracted to the magnets.
- Materials with low coercive forces such as Alnico must be carefully handled and stored when received in a magnetized condition. When stored, these magnets should be maintained on a "keeper", which provides a closed loop protecting the magnet from adverse fields. Bringing together like poles in repulsion can lead to irreversible, although remagnetizable, losses.
- Samarium Cobalt magnets must be carefully handled and stored due to the extremely brittle nature in the material.
- Uncoated Neodymium magnets should be stored in a way to minimize the risk of corrosion.
- Magnetized magnets are considered Hazardous Materials when transporting by air and the stray flux must meet IATA guidelines.
- NdFeB materials, when in powder form, can ignite from static charges

Magnetization Process

To make a magnet "magnetic" it must be exposed to a strong external magnetic field. This field reorganizes the magnet's domain structure and leaves the magnet with a remanent magnetization (B_r). If a magnet is isotropic, the remanent magnetization has the same direction as the external field. Meanwhile, an anisotropic magnet can only be magnetized in its anisotropy direction.

The most common method of magnetizing is to let a very short current pulse go through a conductor or a coil. The short pulse is generated from a magnetization machine, which is basically a powerful capacitor together with a controller. Different materials require different lengths of current pulse. The resistivity of a material provides a prediction of what the magnetization pulse should look like. A material with high resistivity can be magnetized with a pulse of a few micro seconds, while a more conductive material may need several hundreds of a second longer pulse. Also, the volume of a magnet is of importance for the length of the current pulse.

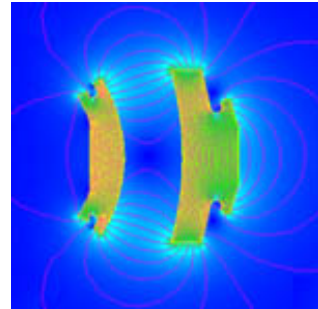

During the magnetizing process, Eddy Currents are produced in an electrical conducting material. Eddy Currents create a magnetic field which is in the opposite direction of the applied field.

Besides various pulse lengths, different materials need different strengths of the magnetizing field. Coercive force (intrinsic) is the property of the material that decides what magnetic field strength that is needed for the magnetization. Axial and diametrical magnetization can be made in standard inductors, i.e. solenoids. However, radial, multiple pole, or any other complex magnetization has to be done in a specially built magnetization fixture.

Magnetizing and Testing Equipment

Magnetizers:

- Capacitive Discharge
- Direct Current
- Half Cycle
- Permanent Magnet



Fixtures:

- Wire Wound Multipole
- Solid Copper Plate
- Wire Wound Solenoids

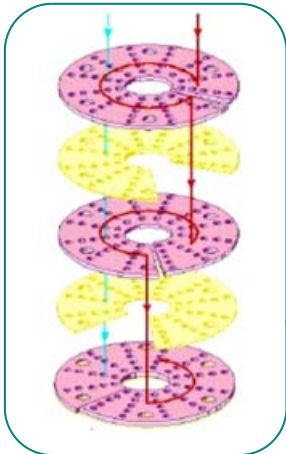

Testing:

- Fluxmeter Coil
- Gaussmeter
- Permeameter



Magnetization Types

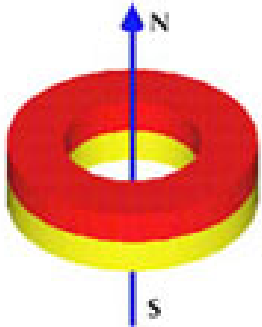

AXIAL

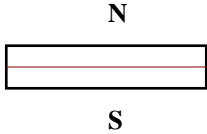

LATERAL

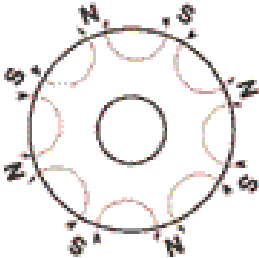

MUTIPOLE

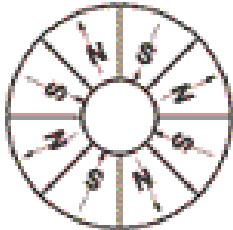

RADIAL

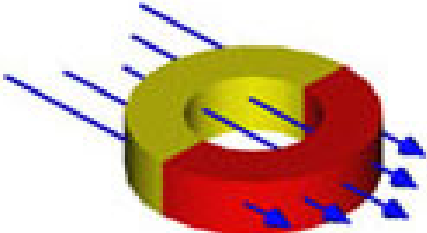
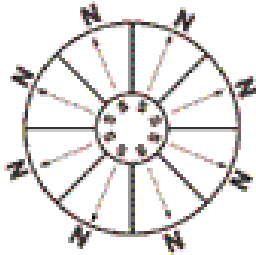

DIAMETRAL



Testing Magnets

A test method or combination of test methods should be based upon the criticality of the requirement, and the cost and ease of performing tests. Ideally, the test results should be able to be directly translated into a functional performance of the magnet. A sampling plan should be specified which inspects the parameters that are critical to the application. Sampling plans can be found in the MMPA 01-100 guidelines.

Hysteresis, Permeameter, BH Curve

B-H curves describe the magnetic properties at a specific temperature. B-H curves may be plotted with the use of a Permeameter. In order to plot a B-H curve, a sample of a specific size must be used and then cycled through a magnetization/demagnetization cycle. This test is expensive to perform due to the length of time required to complete. The test is destructive to the sample piece in many cases, and is not practical to perform on a large sample of finished magnets. However, when magnets are machined from a larger block, the supplier may be requested to provide B-H curves for the starting raw stock of magnet material. The B-H test will essentially provide you the demag properties.

Total Flux

Using a test set up consisting of a Helmholtz coil pair connected to a Fluxmeter, total flux measurements can be made to obtain total dipole moments, and interpolated to obtain close estimates of B_r , H_c , and BH_{max} . The inside diameter of the coils should be at least three times the largest dimension of the magnet for accurate results. The angle of orientation of the magnet can also be determined using this method. This is a quick, repeatable and reliable test, and one that is not overly sensitive to magnet placement within the coil.

Flux Density

Flux density measurements are made using a Gaussmeter and an appropriate probe. The probe contains a Hall Effect device whose voltage output is proportional to the flux density. There are two types of probes: Axial, which measures the flux parallel to the probe holder and Transversal, which measures the flux perpendicular to the probe holder. The position of the probe related to the magnet must be exactly the same between each sample. This can be simplified by using a fixing device.

Pull Force

The pull of magnets is proportional to B (flux density) squared. Variations in B occur due to variations in the inherent properties of the magnet itself, as well as environmental effects such as temperature, composition and condition of the material that the magnet is being tested on. Since B decays exponentially from a zero air gap, small inadvertently introduced air gaps between the magnet and the test material can have a large effect on the measured pull. It is therefore recommended that the test is performed with a small air gap. To achieve the best accuracy on the measurements, the test should be made with various air gaps.

Adhesion

Cross Cut Test

The cross-cut test is a simple and easily practicable method for evaluating the adhesion of single- or multi-coat systems.

Procedure

- Make a lattice pattern in the film with the appropriate tool, cutting to the substrate
- Brush in diagonal direction 5 times each, using a brush pen or tape over the cut and remove with Permacel tape
- Examine the grid area using an illuminated magnifier

Cross-Cut Results

Adhesion is rated in accordance with the scale below.

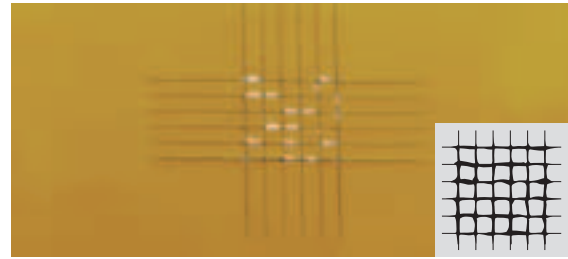

- ISO Class.: 2 / ASTM Class.: 3 B
The coating has flaked along the edges and/or at the intersections of the cuts. A cross-cut area significantly greater than 5 %, but not significantly greater than 15 %, is affected.



- ISO Class.: 0 / ASTM Class.: 5 B
The edges of the cuts are completely smooth; none of the squares of the lattice is detached.



- ISO Class.: 3 / ASTM Class.: 2 B
The coating has flaked along the edges of the cuts partly or wholly in large ribbons, and/or it has flaked partly or wholly on different parts of the squares. A cross-cut area significantly greater than 15 %, but not significantly greater than 35 %, is affected.



- ISO Class.: 1 / ASTM Class.: 4 B
Detachment of small flakes of the coating at the intersections of the cuts. A cross-cut area not significantly greater than 5 % is affected.

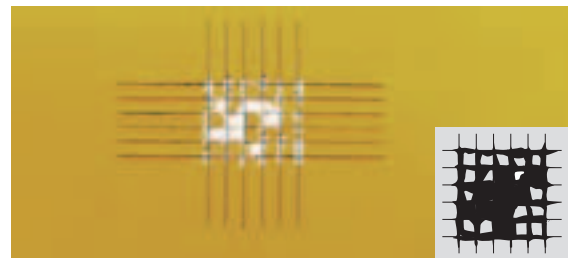

- ISO Class.: 4 / ASTM Class.: 1 B
The coating has flaked along the edges of the cuts in large ribbons and/or some squares have detached partly or wholly. A cross-cut area significantly greater than 35 %, but not significantly greater than 65 %, is affected.

- ISO Class.: 5 / ASTM Class.: 0 B
Any degree of flaking that cannot even be classified by classification 4.

Standards

ASTM	D 3002	D 3359
DIN EN ISO	2409	

Parallel Groove Adhesion Test

Adhesion

Cross Hatch Cutter Kit

The Cross Hatch Cutter Kit provides a practical, low cost and widely used method to evaluate adhesion.

- Measurement of adhesion by tape test
- Simple and easy to use

Each kit comes with a choice of one of three blades: fine blade, medium blade or coarse blade.

Procedure

Uses the procedure on the previous page 106, and can also be used for pull off adhesion by using the included tape.



Standards

ASTM D 3359

Ordering Information

Cat. No.	Description	Price
TAR-8601	Cross Hatch Cutter Kit	\$ 208.00
TAR-8602	Cross Hatch Cutter Kit	\$ 208.00
TAR-8603	Cross Hatch Cutter Kit	\$ 208.00

Comes complete with:

Blade with holder / handle
Hex wrench for changing blades
Extra clamp screw
Small cleaning brush
Lighted magnifier
One roll of Permacel 99 Adhesive Tape
Plastic case

Technical Specifications

Blade	Spacing	No. Of Cutting Teeth
fine	0.04 in (1.0 mm)	11
medium	0.06 in (1.5 mm)	11
coarse	0.08 in (2.0 mm)	6

Ordering Information

Cat. No.	Description	Price
TAR-8640	Replacement Blade	\$ 85.00
TAR-8641	Replacement Blade	\$ 85.00
TAR-8642	Replacement Blade	\$ 85.00
TAR-8660	Replacement Tape	\$ 31.00

Accessories

Blade	Spacing	No. Of Teeth
fine	0.04 in (1.0 mm)	11
medium	0.06 in (1.5 mm)	11
coarse	0.08 in (2.0 mm)	6
Permacel 99, 1 in x 72 yds		

Initial Design Considerations

Prior to using magnetic modeling software, certain considerations must be given to the selection of the magnet material, the application, environment, and long term consequences. Once these have been considered, the magnet material data for most modeling tools can be imported directly into your software by visiting www.matweb.com and searching by **MAGNETS OR ALLIANCE LLC**

Magnet Environment

- Immersed in a fluid – what type
- Sealed enclosure
- Subject to forces – acceleration, shock etc
- Subject to radiation – what type, level and duration
- Temperature extremes in use
- Field strength at operating temperature
- Demagnetization fields

Thermal Properties

- Reversible temperature coefficient of residual induction – α_{Br}
- Reversible temperature coefficient of coercive force – β_{Hc}
- Reversible temperature coefficient of intrinsic coercive force
- Curie temperature
- Maximum service temperature

Selection Based on Required Properties

- Residual induction - B_r
- Coercive force - H_c
- Intrinsic coercive force - H_{ci}
- Maximum Energy Density – $(BH)_{max}$
- Recoil permeability - μ_{rec}
- H_k Value of H_c at $0.9B_r$
- Magnetic flux Φ at required air gap

Selection of Magnet Material

- Shape and required dimensions
- Injection and Compression Bonded or Sintered (fully dense)
- Orientation (Anisotropic) or non-oriented (Isotropic)

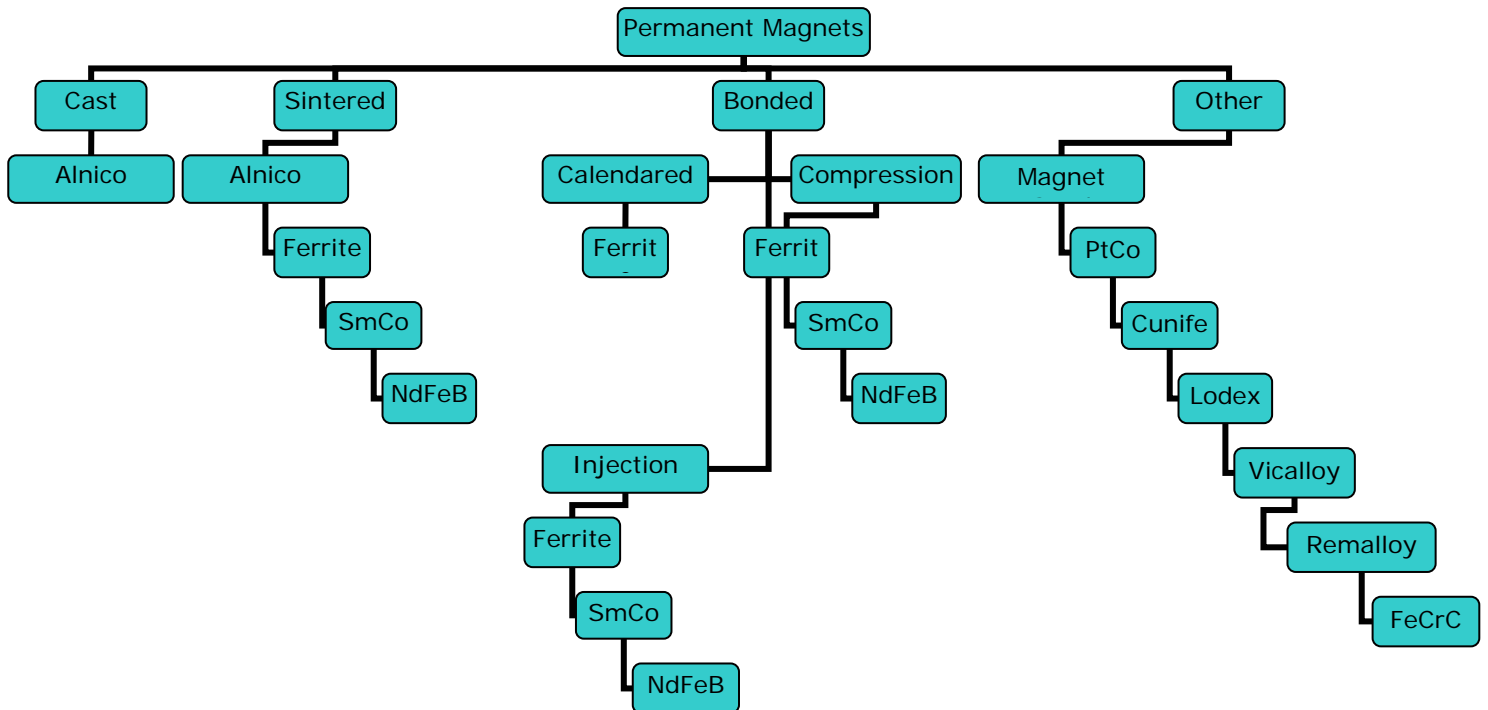

Application and Production Line Factors

- **Non-Coated, Coated, or Plated:**

- Coating Material:

- 1 **Epoxy**
- 2 **Nickel**
- 3 **Ni-Cu-Ni**
- 4 **Zinc**
- 5 **Paralene**

- Method of coating
- Coating thickness
- Color or luster

○ **Magnetized or Not Magnetized:**



- Working Surface
- Magnetic Pattern
- Number of Poles
- Pole Pitch
- Magnetized inside or out of assembly
- Type of Equipment Needed

Specifications That May Be Include In Your Drawing

○ **Dimensional Data**

- Tolerances (do they apply before or after coating or plating)
- Parallelism
- Squareness
- Concentricity
- Surface finish
- If plated, radiuses on edges
- Acceptable Chips, Cracks, Burrs

- **Magnetic Properties** (British or SI, ie. Gauss or Tesla) **with tolerances**
- **Grade of Selected Magnet** (ie. N-35SH for NdFeB)
- **Coating or Plating Specifications** (ie. Ni, Ni-Cu-Ni, Zn, E-coat)
- **Direction of Orientation** (drawn as an arrow through the dimension)
- **Magnetized (# of poles) or Supplied Not Magnetized**
- **Markings for North or South poles**
- **For NdFeB grades add: “Must be Licensed”**

You may find standard recommendations (ex. allowable amount of chipping, magnetic tolerances, etc.) in the MMPA 0100-00 guide. For a free copy of the publication (courtesy of Int'l Magnetism Assoc), and other design guides, please call 219-548-3799 or visit the Alliance website at www.allianceorg.com/design

Additional Items That May or May Not Be Needed

- Conform to certain standards like MMPA 0100-00
- Humidity testing requirements
- Conform to European Union directive 2002/95/EC (RoHS)
- Certificate of Origin
- Material Certifications
- Material Safety Data Sheet (MSDS)
- Testing method for magnetized parts
- If molded, gate and injector pin locations
- Packing Specifications

Please let us know if you have any questions or require assistance with any part of this publication

Material properties and other design information can be found on our web site: www.Allianceorg.com

References:

Sura Magnets AB- Guide to Magnet Design, Guide to Magnet Materials, information from web site www.suramagnets.com. Sura Magnets is a bonded magnet producer in Soderkoping Sweden
MMPA- MMPA 01-100 Guide to Magnetic Properties and the MMPA Design Guide

Information (Material) in this publication is provided solely for the user's information and, while thought to be accurate, is provided strictly "as is" and without warranty of any kind. Alliance LLC, its agents, employees or representatives will not be liable for any damages, direct or indirect, or lost profits arising out of your use of information provided in this publication.

Material in this publication is produced or compiled by Alliance LLC for the purpose of providing general information to our existing or potential customers. Material displayed in this publication is protected by US copyright law and owned by Alliance LLC or the parties identified as having provided the Material. Any copying, posting, or dissemination of this publication, or any part of it, for any purpose whatsoever is strictly prohibited without the express prior written consent of Alliance LLC. To request permission for copying or posting of this publication, or any part of it, please call 219-548-3799 or send a written request to: Alliance LLC, Copyrights and Trademarks, 1150 Eastport Center Drive, Suite G, Valparaiso, Indiana, 46383.